

DialPlus RSR

INSTRUCTION MANUAL



OUTDOOR MODEL



IRRIGATION CONTROLLER

4, 6, 8, 12 or 16 station models available.

HOLMAN
Innovation in Watering



CE

N10372

Rain Sensor Ready

Table Of Contents

Features	1
Glossary	2
Programming Instructions	
Introduction	3
Programming Example	4
Other Functions	5
General tips for programming	5
Programming	
Set Current Time & Correct Day	6
Set Calendar (Optional)	6
Step 1. Set Start Times	7
Step 2. Set Watering Days	8
Interval Day Selection	8
Individual Day Selection	8
Odd / Even Day Selection	9
Step 3. Set Station Run Times	9 - 10
Manual Operations	
Run A Single Station	11
System test facility	11
Run A Program	11
Other Features	
Stop	12
Stacking Start Times	12
Automatic BackUp Program	12
Rain Sensor Ready Feature	13
Rain Off Mode	14
Water Budgeting	14
Fault Finding Guide	15
Installation Instructions	
Mounting The Controller	16
Electrical Hook-Up	16
Field Wiring Connections	17
Terminal Block Layout	17
Power Supply Connections	18
Pump Hook-Up Connections	19
Connection Of Valves + Rain Switch	20
Electrical Characteristics	21
Servicing The Controller	22
Spare Watering Planners	23 - 25

Features

This unit is available in four, six, eight, twelve & sixteen station configurations.

Designed for residential and light commercial applications, this controller has four separate schedules with up to sixteen start times a day to ensure efficient watering of different garden or turf areas.

These different areas may require individual watering schedules and often use different types of sprinklers.

Examples: Turf areas generally use pop-up sprinklers and require less frequent but heavier watering. However, flower beds use micro sprays and require more frequent watering. The valves (stations) which water similar garden areas are often grouped together and put into the same program as they need to be watered on the same days.

These stations (valves) will water in sequential order from the lowest number at the start time (or times) nominated and on the days selected. Maximum watering duration for a station (valve) is 12 hours and 59 minutes.

This controller has a 7 day watering schedule with individual day selection per program or a 365 calendar for Odd/Even day watering or selectable interval watering schedules from everyday to every 15th day.

A feature of this controller is the water saver feature which allows quick adjustment of the station watering times by percentages as the seasons change.

Another key feature of this controller is the Rain Sensor Ready technology (RSR) which allows individual stations to be controlled by a rain switch. The switch will automatically stop the watering programs for nominated valves during wet periods.

Glossary



LCD Display
Easy to read display



SELECTION DIAL
Used for Operations & Programming.

PROGRAMMING BUTTONS
Used for Adjusting programmed information

TERMINAL COVER
Remove to access terminals for solenoid wires & to change 9V battery

Programming Instructions

Introduction

This controller has been designed with four separate programs to allow the different garden areas to have their own individual watering schedules.

A program is basically a method of grouping stations (valves) with similar watering requirements to water on the same days. These stations will water in sequential order from the lowest number at the start time nominated and on the days selected.

The important elements of programming your controller are:

- **Group the stations** (valves) which are watering similar garden areas together.

Examples: Turf, flower beds, pergola areas, vegetables. These different groups may require individual watering schedules.

- **Plan your watering schedule** completing the planner supplied at the back of this book.
- **Set the current time and correct day of the week.**
- **Set the automatic program** for each group of valves by completing the following 3 steps.

1. Set Starts.

This sets the time when the watering schedule is to commence. Note: For each start time, all the valves selected for the program will come on in sequential order. If two start times are set, the valves will come on twice.

2. Set Watering Days.

These are the nominated days when the automatic system will be active.

3. Set Station Run Times.

This sets the watering duration required for each station (valve).

Programming Instructions

Programming Example

A typical example of a 8 station system is outlined below as a guide to assist you when planning your watering schedule. In this example, the lawn areas are using pop-ups and require less frequent watering. The vegetables are being watered using drippers, with the flower beds and pergola areas being watered using micro sprays.

VALVE NUMBER		5	GARDEN BED	11
		6	GARDEN BED	12
1	FRONT LAWN	7	BACK LAWN	13
2	FRONT LAWN	8	PERGOLA	14
3	FRONT LAWN	9		15
4	VEGETABLES	10		16

PROGRAM	START TIME		WATERING INTERVAL	STATION	RUN TIME (minutes)	
	1	2			1	2
1	Start Time 1:	4:00 am	MONDAY WEDNESDAY FRIDAY	1	20	9
	2nd Start Time			2	20	10
	3rd Start Time			3	20	11
	4th Start Time			4		12
	Time			5		13
				6		14
				7	20	15
				8		16
2	Start Time 1:	6:00 am	EVERY DAY	1		9
	2nd Start Time			2		10
	3rd Start Time			3		11
	4th Start Time			4	10	12
	Time			5		13
				6		14
				7		15
				8		16
3	Start Time 1:	5:00 am	EVERY 2nd DAY	1		9
	2nd Start Time			2		10
	3rd Start Time			3		11
	4th Start Time			4	10	12
	Time			5	10	13
				6	10	14
				7		15
				8		16
4	Start Time 1:	7:00 am	EVERY DAY	1		9
	2nd Start Time	6:00pm		2		10
	3rd Start Time			3		11
	4th Start Time			4		12
	Time			5		13
				6		14
				7		15
				8	5	16





Programming Example (cont.)

Other Functions

This controller can also manually run a selected program once, or an individual station can be set to run once from 1 minute up to 12 hours and 59 minutes. During winter the automatic schedules can be suspended to prevent watering while it is raining. This feature can be facilitated for individual stations by using a rain switch or by using the dial if no switch is connected. A test facility for checking the valves and sprinklers is also provided.

General tips for easy programming

Tips to help eliminate programming confusion.

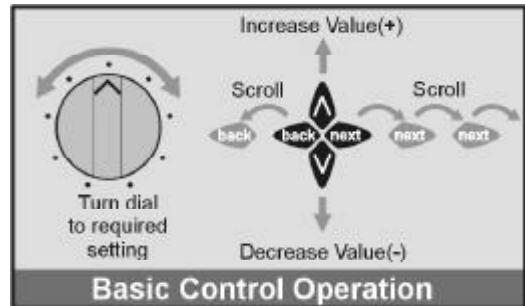

- Complete the spare watering planner.
- When setting, one push of the button will increment one unit.
- Holding one button down will fast scroll through units.
- During programming, only flashing units are able to be set, using  or  buttons.
- Pressing  will scroll forward through the settings in an orderly sequence.
- Pressing  will scroll back to previous settings and settings can be changed.





Programming



Set Current Time & Correct Day

Turn the dial to **Set Clock/Calendar** position. The hour will be flashing.

Use  or  to adjust. Note: AM / PM must be set correctly.

Press the  button and the “minutes” will flash. Use  or  to adjust.



Press  and the “day of the week” will flash.

Use  or  to set correct day.

Set Calendar (Optional)

Note: The calendar only needs to be set when selecting Odd/Even day watering in areas where water restrictions may require this feature.

Press  button until the year, month and day are shown. the “year” will be flashing.

Use  or  to adjust, if required.

Press  button and the “month” will flash.

Use  or  to adjust.

Press  and the “day” will flash.

Use  or  to adjust.

Tip: To return to the clock, press , or turn dial to another position.

Programming

Before proceeding, ensure the spare watering planner has been completed. From your planner you should be aware which stations (valves) are allocated to each program. Set one program at a time to ensure that the schedules are completed correctly.

Example: **SET PROGRAM 1**



Step 1. Set Start Times



(Note: All the valves will come on in sequential order for each start time). Turn the dial to **Set Start Times** and ensure that “Prog 1” is flashing.



The display will show:



Press  and “Start 1” will flash.

Press  and the “hour” will flash. Use  or  to adjust. Note: Ensure AM / PM position is correct

Press  and the “minutes” will flash. Use  or  to adjust, if required. Each program has up to four start times and should you require a second start time,

Press  twice and “Start1” will flash. Advance to start 2 by pressing .

The display will show:



Press  and proceed as per setting **Start 1**.

Tip: To turn an active start time off, turn the dial to **the Set Start times** position, *select* the program number by using

 and then press , *select* the start number required

using the  button. Press  until the “hour” is flashing. Use  or  until “OFF” is shown.

Tip: “OFF” position is between 12 and 1.

Programming

Step 2. Set Watering Days

This unit has interval watering from everyday to every 15th day or individual day selection or a 365 day calendar with odd/even day selection in areas where water restrictions require this feature.

Turn the dial to **Set Watering Days**.

Interval Day Selection

The display will show:

“Interval 1” will be flashing.

This means that watering will occur every day.

To change the interval day, **press** the  button.

Examples: Interval 2 means watering will take place every second day, 3 means watering will take place every third day etc.

Interval watering can be set from everyday to every 15th day. The *Run Day* refers to the number of days before the next watering schedule will occur.



Individual Day Selection





Press the  button

This is the **selectable** day option.

The display will show:

This refers to Mon being Day 1. To turn Monday off, **press**

 button. To leave Monday active, leave as is and advance to Tuesday (day 2) by **pressing** the  button.



Again **press** the  button to set the day off if required followed by  to advance. Continue until all seven days have been set “on”  or “off” .

Programming

Odd / Even Day Selection (Optional)

In some regions users are only allowed to water their gardens on ODD dates if their house number is ODD, or on EVEN dates when their number is EVEN .

This controller allows this to be done simply by setting the relevant selection of ODD or EVEN and setting the current date into the controller. The controller will account for leap years.

If you require the ODD / EVEN day option, simply **press** the  button until “Odd” is shown. **Press** the  button and “Even” will be shown. This feature may be required in areas where water restrictions are enforced.

Note: Remember to set the 365 day calendar when setting the clock, or this feature will be out of sequence. (Refer page 6 “Set Calendar”)

Step 3. Set Station Run Times

This is the length of time that each station (valve) is scheduled to water on a particular program. Maximum watering time is 12 hours 59 minutes for each station. A station can be assigned to 1, 2, 3 or 4 programs if required.

Turn the dial to the **Set Station Run Times** position and the display will show the following:



This means station 1 has a default run time of 10 minutes in program 1. Station 1 will be flashing.

Programming

Step 3. Set Station Run Times. (Continued)

To adjust the **Run time** in minutes press **Next**, and use **▲** or **▼**. To set the run time in hours, press **Next** and "0" will appear and flash. To adjust use **▲** or **▼**. If not required press **Next** and advance to station 2 by pressing the **▲** button.

Continue until all the stations in Program 1 have been set with a run time or if a station (or stations) is not required to be active in this particular program, ensure that the Run time is set to "OFF".

Note: To set a station to "OFF". Use **▼** when the "RUN TIME" is flashing, or press **▲** & **▼** simultaneously.

This completes the setting up procedure for automatic watering of Program 1.

Select from 4 programs for different watering schedules. Should you need the second program to have an automatic schedule, **turn** the dial to "Set Start times" and "Prog 1" will flash. press **▲** and change to program 2 position and follow the same 3 steps for automatic watering.

1. **Set Starts**
2. **Set Watering Days**
3. **Set Station Run Times**

Tip: Remember to return the dial to the "Auto Run" position at the completion of the setting up of the automatic schedules. This will ensure that the automatic cycles will take place.

Manual Operations

Run A Single Station

The maximum Run time for a station is 12 hours 59 minutes. To manually run a single station once, **turn** the dial to **System Test or Run Single Station** position and the display will show:

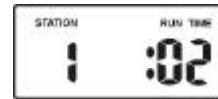

To adjust the Run Time, use the **▲** button and to advance to the next station press the **Next** button.

System Test Facility

This feature can be used to test that your valves and sprinklers are working correctly. **Turn** the dial to

System Test or Run Single Station position and the display will show:



The controller will run through all stations for 2 minutes in sequential order while you go and check your sprinklers.

Note: The system test facility is preset at 2 minutes per station and can NOT be adjusted.

Run A Program

To manually run a complete program once for the run times as set in the automatic schedule. **Turn** the dial to the **Run Program** position. "Prog 1" will be shown in the display. To run program 1, leave or advance to program 2 by pressing **Next**.

Note: If a rain switch is connected and the display shows "SEN WET", the stations set to rain sensor "ON" will not activate. However individual stations can be watered by using the **Run Single Station** facility.

Other Features

Stop

To stop an automatic or manual watering schedule, **turn** the dial to the **Off** position.

Tip: for automatic watering remember to **turn** the dial back to the **Auto Run** position, as the **Off** position will stop any watering cycles from occurring.

Stacking Start Times

Should you accidentally set the same watering start time on more than one program, the Controller will stack them in sequential order from the lowest number. All programmed start times will be watered, but the start times will be shunted along.

Automatic BackUp Program

When the battery is not fitted or is flat there is a backup default program in program 1 watering every day at 12:00am for 10 minutes per station.

A standard 9 volt alkaline block battery should be fitted to the battery snap supplied to maintain the clock accuracy and hold the automatic programs during power outs.

Tip: The display has a warning indicator to let you know when the battery is low or not fitted. The word **BAT** appears just under the AM / PM indicator when the clock is shown.

Other Features

Rain Sensor Ready Feature

This feature is only used when a rain switch has been connected. When using a standard rain switch, first disconnect the factory fitted link. Now, connect the cables from the switch to the terminal blocks marked "**COM**" & "**RAIN**". **Turn** the dial to **Rain Sensor Selection** to enable individual stations to be set rain sensor "ON" or "OFF".

Display will show:



Note: All stations are set "OFF" at first power up.

The stations set to "OFF" will water automatically at all times and the stations set to "ON" will be controlled by the rain switch. IE: The stations set to "ON" will not water automatically with the rain switch in the "WET" mode. To

set individual stations to "ON" press  button and

advance by pressing . Continue until all stations are set "ON" for rain sensor control or "OFF".

Display will show:



Tip:

If the display is showing "SENS WET" and you need to override the rain switch, disconnect the rain switch cables at the terminal and install a link between "**COM**" & "**RAIN**". This link completes the circuit that has been opened when the rain switch is wet. Both the "test cycle" and "individual station run" will work regardless of whether the sensor is wet or dry.



LINK: Overrides rain switch

Other Features

Rain Off Mode

To stop the automatic watering cycles during winter, **turn** the dial to the **Off** position. The word “Off” will appear in the display. This means the automatic schedules will not come on, but the programmed information is still retained in the memory. To reactivate the automatic schedule, **turn** the dial back to the **Auto Run** position.

NOTE: If a rain switch has been connected, it will turn the stations set to rain sensor control, off, automatically when the switch is wet.

Water Budgeting

The automatic station run times can be adjusted by percentage as the seasons change. This will save time and money as the run times can be adjusted quickly in spring, winter and autumn to reduce the amount of water used.



Ensure that the dial is in the **Auto Run** position and then **press** the **psck** and **uxx** buttons simultaneously.

The display will show:



Displayed is the word “Budget” and “100%”. This represents the current automatic watering run times as being 100%. The percentage budget can be set in 25% increments from 25% up to 150%.

Example: 50% reduces watering by half.

To adjust in 25% increments, use  or  buttons.

To return to the clock **press** the **psck** and **uxx** buttons simultaneously. The display will show the word *Budget* to indicate that the water budgeting feature is in use.

Fault Finding Guide

Symptom	Possible Cause	Suggestion
No display.	Faulty transformer. Fuse blown.	Check fuse. Check field wiring. Check transformer.
Single Station not working.	Faulty solenoid coil.	Swap faulty station wire on controller terminal block with known working station wire. If the faulty valve still does not work on the known working connection then the solenoid coil is faulty. The panel may need to be repaired.
Fuse blows.	Incorrect wiring or bad wiring joint.	Check wiring and joints.
No automatic start.	Incorrect programming or blown fuse.	If unit works manually check programming. Check fuse and field wiring.
Buttons on keypad not responding.	Short on keypad or Programming not correct.	Check instruction book to ensure programming correct. If keypad still not responding return panel to supplier or manufacturer.
System coming on at random.	Short on keypad or too many start times entered on automatic programs.	Check number of start times entered on each program. If programming is correct return panel to supplier or manufacturer.
More than 1 station coming on at once.	Damaged main output driver chip.	Check wiring and swap faulty station wire(s) on controller terminal block with known working station wire. If the same outputs are still locked on, return panel to supplier or manufacturer.
Pump start chattering.	Faulty relay or pump contactor.	Electrician to check voltage on pump relay or contactor.
Display cracked or missing segments.	Display damaged during transportation.	Return panel to supplier or manufacturer.

Installation Instructions

Mounting The Controller

Install the controller near a 240V AC mains outlet, preferably located in a house, garage or other covered area. For ease of operation, eye level placement is recommended.

Ideally, your controller location should not be exposed to rain or water ingress.

INBUILT MODEL:

The inbuilt controller unit is an OUTDOOR MODEL and can be exposed to light rain & is waterproof.

Fasten the controller using the two mounting holes positioned externally on the top, and the additional hole positioned internally under the terminal cover.

Electrical Hook-Up

WARNING

- 1 All electrical work must be carried out in accordance with these instructions following all applicable Local, State and Federal codes, or warranty will be void.**
- 2 Disconnect mains power supply before maintenance work to controller or valves and when connecting and disconnecting field wiring and pump or master valve hook-ups.**

Installation Instructions

Field Wiring Connections

PREPARATION

- 1 Prepare wires for hook-up by cutting the wires to the correct length and stripping approximately 6.0mm (¼ inch) of insulation from the end to be connected to the controller.**
- 2 Ensure terminal block screws are loosened sufficiently to permit easy access for wire ends. Insert stripped wire ends into the clamp aperture and tighten screws. *Do not* over tighten as this may damage the terminal block.**
- 3 A maximum of 0.75 Amps may be supplied by any output. Check the inrush current of your solenoid coils before connecting more than two valves to any one station.**

Terminal Block Layout

The terminal block is laid out as follows:

EG: 8 station

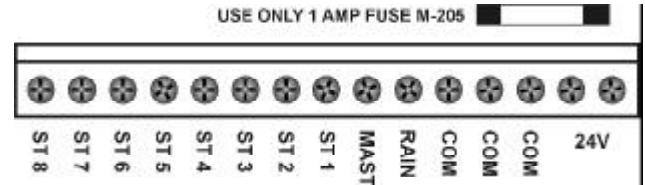

GLOSSARY

AC	24VAC Power Supply
RAIN	Rain switch wire input
COM	Common valve wire input
MAST	Master valve or pump start active wire
ST1 to ST8	Station (Valve) active wire connection

Installation Instructions

Power Supply Connections

Inbuilt Transformer

The inbuilt controller is already wired up and comes complete with 1 metre of lead and a 2 pin plug which is suitable for a normal power board (240V AC mains outlet). Simply insert the plug and turn on the power.

It is recommended that the transformer is not connected to a 240V AC supply which is also servicing or supplying motors (i.e. Air conditioners, pool pumps, refrigerators, etc.) Lighting circuits are suitable as a power source.

This inbuilt transformer model, is suitable for outdoor installation as the housing is waterproof and UV stabilised. However, it is recommended that the unit be installed in an area which is not exposed directly to the weather such as under the eaves or verandah.

Connections to the unit are as follows:

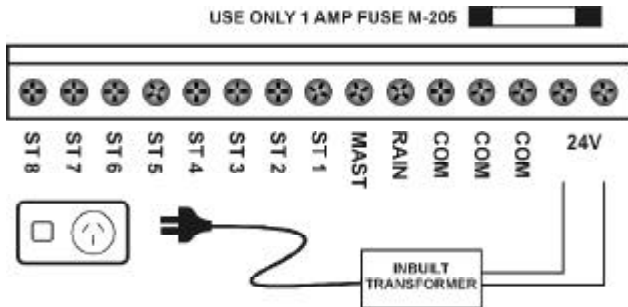

REPLACE 9V BATTERY ANNUALLY

Installation Instructions

Pump Hook-Up Connections

Do not attempt to drive a pump starter directly from the controller. Pump start is provided by connecting one side of the coil of a suitable relay to the Master Valve/Pump Start output of the controller and the other side to the controller common.

For systems supplied with water from a Pump, unused stations must be connected back to the last used station to eliminate the possibility of the pump running against a closed head. Failure to do so could lead to pump damage.

The diagram shows an 8 Station Controller:

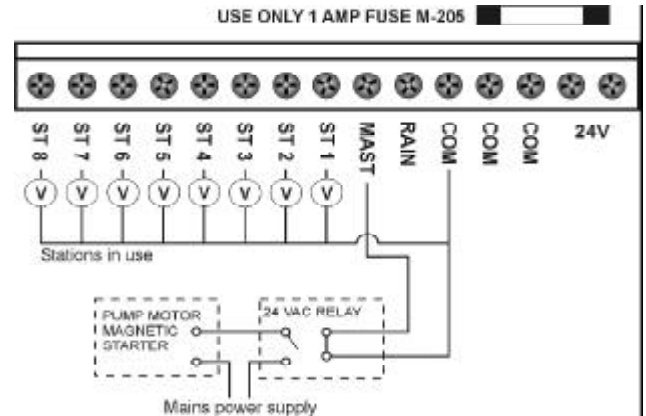

Installation Instructions

Connection Of Valves & Rain Switch

Up to three 24VAC Solenoid Valves can be connected to each station output and wired back to the common (COM) thus:

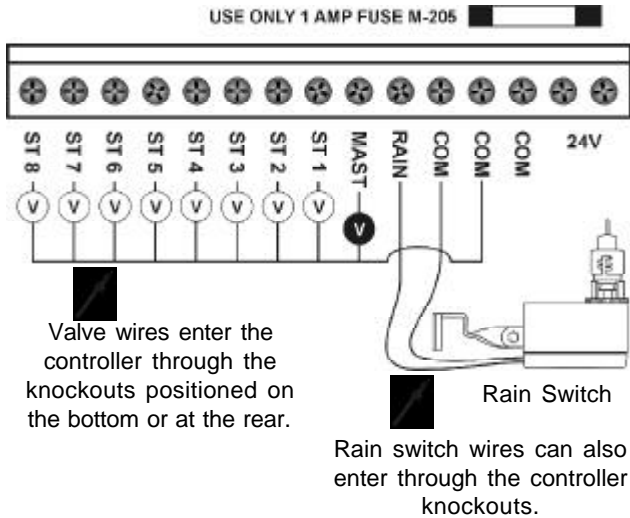

Electrical Characteristics

Electrical Outputs

Power Supply

MAINS SUPPLY: This unit is factory fitted with a 30VA rated transformer 220 - 240VAC 50Hz delivering 24VAC.

Electrical Power Supply:

Input: 24Volts AC 50Hz.

Electrical Outputs: Maximum of 1.0 AMP

To Solenoid Valves:

24 VAC 50/60 Hz 0.75 AMPs max.

(NOTE: Up to 3 valves with the inbuilt model.)

To the Master Valve/Pump Start:

24VAC 0.25 AMPs max.

(NOTE: Transformer and fuse capacity must be compatible with output requirements.)

Overload protection: Standard 20mm 1 AMP fuse.

Power failure: 9 Volt block type battery maintains clock and programs for up to 4 weeks.

Wiring: The output circuits should be installed and protected in accordance with wiring rules.



Servicing The Controller

The Controller should always be serviced by an authorized agent.

Follow these steps:

- 1 Turn Mains power off to the controller.
 - 2 Disconnect 24 Volt power leads at the controller 24VAC terminals.
 - 3 Clearly mark or identify all valve wires according to the terminals they are connected to, (1 to 16). This allows you to easily wire them back to the Controller, maintaining your valve watering sequence.
 - 4 Disconnect valve wires from the terminal block.
 - 5 Remove the complete unit from the wall.
 - 6 Carefully wrap the complete unit in protective wrapping and pack in a suitable box. Return to your service agent or the manufacturer.
- Note:* Tampering with the unit will cancel the Guarantee
- 7 Replace your controller by reversing this procedure.

Spare Watering Planner

VALVE NUMBER	5		11	
	6		12	
1	7		13	
2	8		14	
3	9		15	
4	10		16	
PROGRAM				
	START TIME	WATERING INTERVAL	STATION	START TIME (minutes)
1	Start Time 1:		1	9
	2nd Start Time:		2	10
	3rd Start Time:		3	11
	4th Start Time:		4	12
			5	13
			6	14
			7	15
			8	16
2	Start Time 1:		1	9
	2nd Start Time:		2	10
	3rd Start Time:		3	11
	4th Start Time:		4	12
			5	13
			6	14
			7	15
			8	16
3	Start Time 1:		1	9
	2nd Start Time:		2	10
	3rd Start Time:		3	11
	4th Start Time:		4	12
			5	13
			6	14
			7	15
			8	16
4	Start Time 1:		1	9
	2nd Start Time:		2	10
	3rd Start Time:		3	11
	4th Start Time:		4	12
			5	13
			6	14
			7	15
			8	16

Spare Watering Planner

VALVE NUMBER		5	6	11	
1		7	8	13	
2		8	9	14	
3		9	10	15	
4		10		16	

PROGRAM						
	START TIME	WATERING INTERVAL	station	RUN TIME (minutes)	station	RUN TIME (minutes)
1	Start Time 1:		1	9	2	10
	2nd Start Time:		3	11	4	12
	3rd Start Time:		5	13	6	14
	4th Start Time:		7	15	8	16
	Start Time 1:		1	9	2	10
	2nd Start Time:		3	11	4	12
	3rd Start Time:		5	13	6	14
	4th Start Time:		7	15	8	16
2	Start Time 1:		1	9	2	10
	2nd Start Time:		3	11	4	12
	3rd Start Time:		5	13	6	14
	4th Start Time:		7	15	8	16
	Start Time 1:		1	9	2	10
	2nd Start Time:		3	11	4	12
	3rd Start Time:		5	13	6	14
	4th Start Time:		7	15	8	16
3	Start Time 1:		1	9	2	10
	2nd Start Time:		3	11	4	12
	3rd Start Time:		5	13	6	14
	4th Start Time:		7	15	8	16
	Start Time 1:		1	9	2	10
	2nd Start Time:		3	11	4	12
	3rd Start Time:		5	13	6	14
	4th Start Time:		7	15	8	16
4	Start Time 1:		1	9	2	10
	2nd Start Time:		3	11	4	12
	3rd Start Time:		5	13	6	14
	4th Start Time:		7	15	8	16
	Start Time 1:		1	9	2	10
	2nd Start Time:		3	11	4	12
	3rd Start Time:		5	13	6	14
	4th Start Time:		7	15	8	16

Spare Watering Planner

VALVE NUMBER		5	6	11	
1		7	8	13	
2		8	9	14	
3		9	10	15	
4		10		16	

PROGRAM						
	START TIME	WATERING INTERVAL	station	RUN TIME (minutes)	station	RUN TIME (minutes)
1	Start Time 1:		1	9	2	10
	2nd Start Time:		3	11	4	12
	3rd Start Time:		5	13	6	14
	4th Start Time:		7	15	8	16
	Start Time 1:		1	9	2	10
	2nd Start Time:		3	11	4	12
	3rd Start Time:		5	13	6	14
	4th Start Time:		7	15	8	16
2	Start Time 1:		1	9	2	10
	2nd Start Time:		3	11	4	12
	3rd Start Time:		5	13	6	14
	4th Start Time:		7	15	8	16
	Start Time 1:		1	9	2	10
	2nd Start Time:		3	11	4	12
	3rd Start Time:		5	13	6	14
	4th Start Time:		7	15	8	16
3	Start Time 1:		1	9	2	10
	2nd Start Time:		3	11	4	12
	3rd Start Time:		5	13	6	14
	4th Start Time:		7	15	8	16
	Start Time 1:		1	9	2	10
	2nd Start Time:		3	11	4	12
	3rd Start Time:		5	13	6	14
	4th Start Time:		7	15	8	16
4	Start Time 1:		1	9	2	10
	2nd Start Time:		3	11	4	12
	3rd Start Time:		5	13	6	14
	4th Start Time:		7	15	8	16
	Start Time 1:		1	9	2	10
	2nd Start Time:		3	11	4	12
	3rd Start Time:		5	13	6	14
	4th Start Time:		7	15	8	16

Your Guarantee

The manufacturer Guarantee to the original purchaser that any product supplied by the manufacturer will be free from defects in materials and workmanship for a period of five years from the date of purchase. Any product found to have defects in material or workmanship within the period of this Guarantee shall be repaired or replaced by the manufacturer **FREE OF CHARGE**.

The guarantor does not guarantee the fitness for a particular purpose of its products and does not make any guarantee, expressed or implied, other than the guarantee contained herein. The guarantor shall not be liable for any loss from use of the product or incidental or consequential damages including damages to other parts of any installation of which this product is part.

The guarantee shall not apply to any equipment which is found to have been improperly installed, set up or used in any way not in accordance with the instructions supplied with this equipment, or to have been modified, repaired or altered in any way without the express written consent of the company. This guarantee shall not apply to any batteries or accessories used in the equipment covered under this guarantee or to any damage which may be caused by such batteries.

If the Controller develops a fault, the product or panel must be returned in adequate packing with:

1. A copy of your original invoice.
2. A description of any fault.



It is the purchasers responsibility to return the Controller to the manufacturer or their agent by pre-paid freight.

HOLMAN INDUSTRIES

HEAD OFFICE

463 Scarborough Beach Road.
Osborne Park. Western Australia. 6017.

Tel: +61 8 9204 1011 Fax: +61 8 9204 1013

VICTORIAN WAREHOUSE

94 Northgate Drive.
Thomastown. VIC. 3074.

Tel: 03 9464 5355

Email: sales@holmanindustries.com.au

www.holmanindustries.com.au