



K RAIN® **EX618**TM

- STATION MODELS** – Available in 6, 8, 12 and 18 stations
OUTDOOR MODEL – Supplied with a 240VAC 50Hz Inbuilt Transformer, Lead & Plug

INSTRUCTION MANUAL

CONTENTS

Introduction	1	Special Functions	
Glossary	2	Current sensing and faulty station skip	21
Key Features	3	Fault indication feature	21
Programming Instructions		Pressure Build (bld)	22
Introduction	4	Pressure Relief (rELF)	23
Set automatic program	4	Well Recharge (rECH)	24
Programming example	5	Auxiliaries - Looping	25-27
Spare watering planner	6	Clearing the programs	28
General tips for easy programming	7	Program rescue feature	28
Programming		Installation Instructions	
Set current time & correct day	8	Mounting the controller	29
Set calendar	8	Electrical hook-up	29
Set start times	9	Field wiring connections	29-30
Set watering days	10-11	Terminal block layout	30
Set station run times	11-12	Pump Start Relay Connection	31
Manual Operations		Single phase pump installation	31
Run a single station	13	Master valve installation (including rain sensor)	32
Current test feature	13	Power supply connections	32
Run a program	14	Station (valve) installation	33
Manually test all stations	15	Pump protection (system test)	34
Stop watering	16	Fault Finding Guide	35-36
Stacking start times	16	Electrical Characteristics	37
Automatic back up	16	Electrical outputs	37
Other Features		Electrical power supply	37
Rain sensor	17	Overload protection	37
Rain delay	18	Power failure	37-38
STOP all watering	18	Servicing the controller	38
Dual pump selection	18	Spare watering planner	39
Dual pumps by program	19	Guarantee	
Water budgeting & seasonal adjustment	20		

INTRODUCTION

EX618™ is available in 6, 8, 12 and 18 station configurations. Designed to cover a wide range of applications from residential and commercial turf, to light agriculture, and professional nursery.

This controller has a possible 6 separate programs with up to 36 starts per day. The controller has a 7 day watering schedule with individual day selection per program or a 365 calendar for odd/even day watering or selectable interval watering schedules from every day to every 15th day. Individual stations can be allocated to one or all programs and can have a run time of 1 minute to 12 hours 59 minutes or 25 hours if the water budget is set to 200%. Now with “Water Smart Seasonal Set” which allows the automatic run times to be adjusted in percentage from “OFF” to 200% per month.

K-Rain has always been concerned with sustainable water usage. The controller has many water saving features that can be used to maintain the highest standard of plant quality with the least amount of water consumption. The integrated budget facility allows global changes of run times without affecting programmed run times. This allows for decreasing total water consumption on days of minimal evaporation.

CORRECT POWER UP PROCEDURE

Note: The blue backlit display will light up when connected to AC power, or when a 9V battery has been installed.

- 1) Connect to AC Power
- 2) Install 9V Battery. The 9V Battery is important as it increases the life of the coin battery, as well as allowing remote programming without mains power.

GLOSSARY

LARGE BACKLIT LCD

Displays all programming information.

LARGE MENU BUTTONS

Easy operation with fast scroll feature for entry and review.

QUICK PROGRAM SELECTION KEY

The "P" key allows faster program entry and review.

INTERFACE DECAL

FRONT MOUNTED SENSOR SWITCH

ON/OFF switch for easy access to override

LARGE SELECTION DIAL

Navigates through all programming information.

TERMINAL COVER

Easy to remove for easy access.

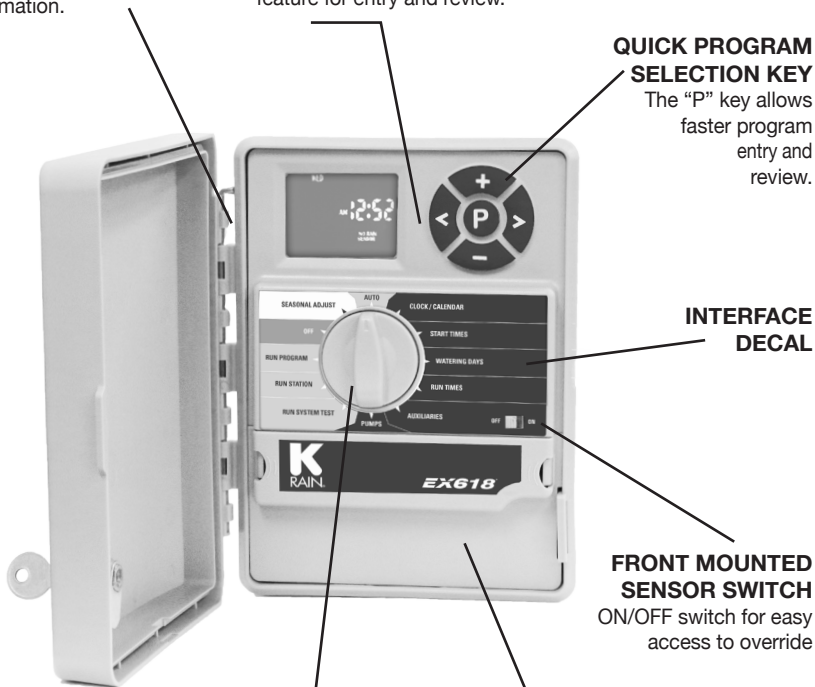

KEY FEATURES

- 6, 8 12 and 18 station models.
- Toroidal high capacity transformer rated to 1.25AMP (30VA):
- Outdoor model with an inbuilt transformer includes lead & plug, for Australia.
- 6 programs, each of which has 6 start times. Maximum of 36 start times per day.
- Station run times from 1 minute to 12 hours & 59 minutes.
- Selectable watering options:
 - Individual 7 day selection.
 - Even, Odd or Odd -31.
 - Interval watering day selection from every day to every 15th day.
- Watering budgeting feature allows quick adjustment of the station run times by percentage, from “OFF” to 200%, by month.
- Rain sensor input will turn off all stations or selected stations during wet periods, if a sensor is installed.
- Permanent memory feature will retain automatic programs during power failures.
- Dual pump selection, by station or by programs.
- Manual functions:
 - Run a program or group of programs once.
 - Run a single station.
 - Run a test cycle for all stations.
 - “OFF” position, stops a watering cycle or to stop automatic programs during winter.
- Pump or master valve input is standard.
- Real time clock backed up with 3V Lithium battery (pre-fitted)
- Current sensing and faulty station skip
- Backlit display allows day or night time programming.
- Contractor recall feature
- Pressure build feature, with a gap in seconds between stations.
- Pressure relief feature, with an overlap in seconds between stations.
- Well recharge feature which allows a programmed time for the pump to be turned off between stations.
- Looping feature allows stations to run in seconds or minutes with a delay in mins/ hrs between cycles. Select up to 99 cycles or continuous cycle option.

PROGRAMMING INSTRUCTIONS

INTRODUCTION

This controller has been designed with 6 separate programs to allow different landscape areas to have their own individual watering schedules.

A program is a method of grouping stations (valves) with similar watering requirements to water on the same days. These stations will water in sequential order and on the days selected.

- **Group the stations** (valves) which are watering similar landscape areas together.
Examples: Turf, flower beds, gardens. These different groups may require individual watering schedules, or programs
- **Plan your watering schedule** completing the planner supplied at the back of this book.
- **Set the current time and correct day** of the week. If odd or even day watering is going to be used, make sure the current year, month and day of the month is correct.

HINT: To select a different program use the button marked **P**. Each press will move to the next program number. This is handy for quick reviewing of previously entered information without losing your place in the programming cycle.

SET AUTOMATIC PROGRAM

- Set the automatic program for each group of stations (valves) by completing the following three steps:

1. Set start times

This sets the time when the watering schedule is to commence.

Note: For each start time, all the stations (valves) selected for the program will come on in sequential order. If two start times are set, the stations (valves) will come on twice.

2. Set Watering Days

These are the selected days when the automatic system will be active.

3. Set Station Run Times

This sets the watering duration required for each station (valve).

SPARE WATERING PLANNER

VALVE NUMBER		6	7	13
1				
2				
3				
4				
5				
PROGRAM				
START TIME	WATERING INTERVAL	STATION	RUN TIME (minutes)	RUN TIME (minutes)
1		1	10	10
2nd Start Time:		2	11	11
3rd Start Time:		3	12	12
4th Start Time:		4	13	13
5th Start Time:		5	14	14
6th Start Time:		6	15	15
7th Start Time:		7	16	16
8th Start Time:		8	17	17
9th Start Time:		9	18	18
2		1	10	10
2nd Start Time:		2	11	11
3rd Start Time:		3	12	12
4th Start Time:		4	13	13
5th Start Time:		5	14	14
6th Start Time:		6	15	15
7th Start Time:		7	16	16
8th Start Time:		8	17	17
9th Start Time:		9	18	18
3		1	10	10
2nd Start Time:		2	11	11
3rd Start Time:		3	12	12
4th Start Time:		4	13	13
5th Start Time:		5	14	14
6th Start Time:		6	15	15
7th Start Time:		7	16	16
8th Start Time:		8	17	17
9th Start Time:		9	18	18
4		1	10	10
2nd Start Time:		2	11	11
3rd Start Time:		3	12	12
4th Start Time:		4	13	13
5th Start Time:		5	14	14
6th Start Time:		6	15	15
7th Start Time:		7	16	16
8th Start Time:		8	17	17
9th Start Time:		9	18	18
5		1	10	10
2nd Start Time:		2	11	11
3rd Start Time:		3	12	12
4th Start Time:		4	13	13
5th Start Time:		5	14	14
6th Start Time:		6	15	15
7th Start Time:		7	16	16
8th Start Time:		8	17	17
9th Start Time:		9	18	18
6		1	10	10
2nd Start Time:		2	11	11
3rd Start Time:		3	12	12
4th Start Time:		4	13	13
5th Start Time:		5	14	14
6th Start Time:		6	15	15
7th Start Time:		7	16	16
8th Start Time:		8	17	17
9th Start Time:		9	18	18

PROGRAMMING

This controller has been designed for quick intuitive programming. Remember these simple tips for hassle free programming.

1. Complete the spare watering planner at the back of this book.
2. When setting, one push of the button will increment one unit.
3. Holding one button down will fast scroll through units.
4. During the programming, only flashing units are able to be set.
5. Adjust flashing units using the **+** or **-** buttons.
6. Pressing **▶** will scroll forward through the settings in an orderly sequence.
7. Pressing **◀** will scroll back to previous settings and setting can be changed.

The large dial is the primary device for selecting an operation. Rotate the dial to the function you wish to alter or review.

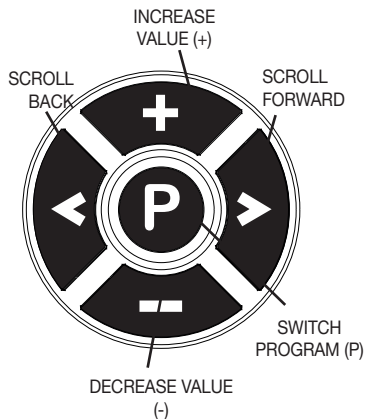
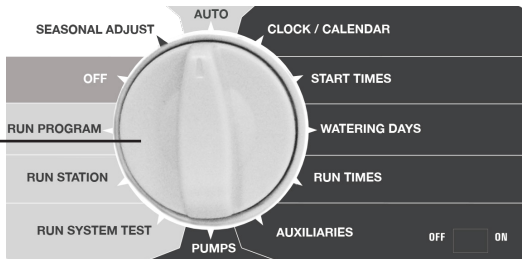

The **P** is used to select different programs. Each push on this button will increment one program number. Once you have selected the primary function and program you wish to alter, you can then use the **+** or **-** to change that function's value. Only display elements that are flashing can be altered with the **+** **-** keys. Use the **◀▶** to scroll through other values within the function that can be altered.

PROGRAMMING

Set current time & correct day

Turn the dial to “Clock/Calendar” position.

The minutes will be flashing. Use the **+** or **■** to adjust.

Press **▶** button and the “hour” will flash. Use **+** or **■** to adjust.

NOTE: AM/PM must be set correctly.

Press **▶** and the “day of the week” will flash. Use **+** or **■** to set the correct day.

Set Calendar

NOTE: *The calendar only needs to be set when selecting Odd/Even day watering in areas where water restrictions may require this feature, or when setting the seasonal adjust feature by month.*

Press **◀** button until the year, month and day are shown. The “year” will be flashing. Use **+** or **■** to adjust if required.

Press **◀** and the “month” will flash. Use **+** or **■** to adjust if required.

Press **◀** and the “date” will flash. Use **+** or **■** to adjust if required.

HINT: To return to the clock, turn dial to another position.

Before proceeding, ensure the spare watering planner has been completed. From your planner, you should be aware which stations (valves) are allocated to each program. Set one program at a time to ensure that the schedules are completed correctly.

PROGRAMMING

Example: SET PROGRAM 1

Step 1 – SET START TIMES

NOTE: all stations will come on in sequential order for each start time.

Turn the dial to “Start Times” and ensure that “Prog No 1” is showing. If not, then use the **P** button to select “Prog No 1”.

The “Start No” will be flashing. The display will show:



Use **+** or **■** to change the “Start No” if required, otherwise press **▶** and the “hour” will flash. Use **+** or **■** to adjust if required.

NOTE: Ensure AM/PM position is correct.

Press **▶** and the “minutes” will flash. Use **+** or **■** to adjust if required.

Each program has up to 6 start times. Should you require a second start time, press **▶** and ‘Start 1’ will flash.

Advance to “Start 2” by pressing **+**

The display will show:

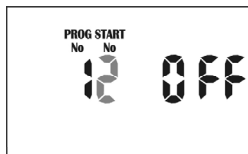

Press **▶** and proceed as per setting Start 1.

HINT: To toggle a start on or off press **+** or **■** when the hour is flashing. To change to a different program either to review or alter, press the **P** button. Every press will increment to the next program.

PROGRAMMING

Step 2 – SET WATERING DAYS

This unit has **individual** day selection, EVEN/ODD/ ODD -31 Date selection in areas where water restrictions require this feature, or **interval** watering from every day to every 15th day.

INDIVIDUAL DAY SELECTION

Turn the dial to “Watering Days” and ensure that “Prog No 1” is showing. If not, then use the **P** button to select “Prog No 1”.

“MON” will be flashing. The display will show:



To turn Monday off press the **■** button. To turn it back on press the **+** button. To advance to the next day use the **▶** button, the display will then flash “Tue”.

Use **+** or **■** to turn days ON or OFF and advance to the next day using **▶**. Remember to set all 7 days ON or OFF. Active watering days will be shown by the **●** under the DAY.

ODD/EVEN DATE SELECTION (Optional)

In some regions users are only allowed to water their gardens on **odd** dates if their house number is **odd**, or **even** dates when their house number is **even**.

This controller allows this to be done simply by setting the relevant selection of odd or even and setting the current date into the controller. The controller will account for leap years.

If you require the odd/even date option, simply keep pressing the **▶** button until “Even” is shown. Press the **▶** button and “Odd” will be shown. Press **▶** again and “Odd -31” will be shown.

This feature may be required in areas where water restrictions are enforced, and not allowing watering on two odd dates together.

NOTE: Remember to set the 365 day calendar when setting the clock, or this feature will be out of sequence (refer page 8 “set calendar”).

PROGRAMMING



INTERVAL DAY SELECTION

Press the  button until “interval days” is flashing.

The display will show:

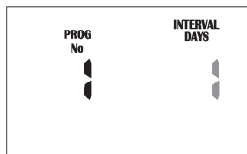
“Interval 1” will be flashing. This means the controller will water every day.



For example, if it showed “1” then in one day’s time the controller will run this program. To change the interval day, press the  or  button.

Select from 1 to 15 interval days.

NOTE: When changing the interval day, the next active day is always changed to 1. This means that tomorrow is the first active day to run.

Step 3 – STATION RUN TIMES

This is the length of time that each station (valve) is scheduled to water on a particular program. Maximum watering time is 12 hours 59 minutes for each station. A station can be assigned to any or all of the possible 6 programs, if required.

Turn the dial to the “Run Times” position.

The display will show:

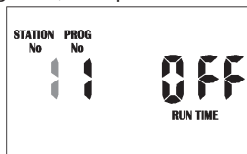

NOTE: This means that station 1 of program 1 has no run time programmed in it. The controller has permanent memory so when the device is first used there will be no run times set. Unlike other controllers, when there is a power failure, even if the battery is not installed, the programmed values will be restored to the unit.

PROGRAMMING

Step 3 - Station Run Times (cont.)

Press **+** or **0** button to select the station (valve) number, and press the **▶** button and the run time minutes will flash. Alter by using **+** or **0**.

Press the **▶** button and the run time hours will flash. Alter by using **+** or **0**.

Press the **▶** button and the current station will flash. Select the next station to change by using **+** or **0** and proceed by pressing **▶** and alter using **+** or **0**.

Continue until all the stations in Program1 have been set with a run time or if a station(s) is not required to be active in this particular program, ensure that the run time is set to "OFF".

NOTE: To turn a station "OFF" press the **0** when the minutes are flashing, and **0** when the hours are flashing.

This completes the setting up procedure for automatic program 1.

Select from up to 6 programs using the **P** button for different watering schedules. On every press of the **P** button the program number will increment. Once on the desired number, follow the three steps to set an automated program:

1. Set start Times
2. Set Watering Days
3. Set Station Run Times

TIP: Although the controller will run automatic programs with the main dial in any position (with the exception of "OFF"), it is advisable to leave the main dial in the "AUTO" position when not programming or running manual stations or programs.

MANUAL OPERATIONS

Run a Single Station

The maximum run time for a station is 12 hours 59 minutes. To manually run a single station once, turn the dial to the “Run Station” position.

The display will show:

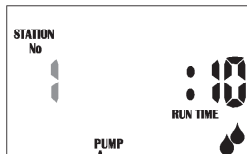

The default run time for a single station is 10 minutes.

Advance to the selected station by pressing **+** as many

times as required, and then press **▶** to adjust the run time with **+** and **■**.

The controller will start running the selected station and the run time will decrement in the display.

If there is a pump or master valve connected, “PUMP A” will be shown in the display. Indicating that the pump/master is running. As soon as the single station run time has elapsed, the unit will revert back to automatic mode. This means that if you forget to turn the dial back to the “Auto” position, the controller will still run its automatic starts, as scheduled. To turn the station off, change the position of the main dial, to “OFF”.

Current Test Feature

When the dial is in the “Run Station” position, press **◀** button to show the current AMPs for the selected station. As this controller has an electronic fuse (set at 1.50AMPs), this is an important feature to show how much current each station is drawing. If the current AMPs are higher than 1.50AMPs the electronic fuse will turn the station “Off”. This usually means that there is a fault with the solenoid coil or a short in the wiring. This fault needs to be fixed as the controller will skip the faulty station in the “AUTO” run mode and no watering will occur in that area of the garden.

The display will also show the faulty station number and beep until midnight.

Press **▶** to return to the station that you are testing. Each station can be tested by pressing **+** and then **◀**.

MANUAL OPERATIONS

Run a Program

To manually run a complete program or to stack multiple programs to run, rotate the dial to “Run Program”. The word “OFF” will be flashing.

The display will show:

To enable program 1 to start press the **+** button.
The icon “OFF” will change to “ON”.

This program has now been enabled so that it can be run. To make program 1 run, press the **▶** button.

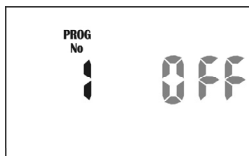

NOTE: *So long as there are run times in program 1 then program 1 will start and water the stations associated with it.*

There may be times when it is desirable to run more than one program manually. The controller allows this to occur using its unique facility of enabling a program, before running it. For example if I wished to run Program 1 and also Program 2, the controller will manage stacking of the programs so they do not overlap.

Enable program 1 by pressing the **+** button. To select the next program press the **P** button, the program number will increment to program 2.

Enable program 2 to run by pressing the **+** button.

NOTE: *to disable a program number, press the **■** button.*

Once both programs have been enabled, they can be run by pressing the **▶** button. The controller will now run all programs that have been enabled starting with the lowest numbered program. So in this case, program 1 would run and when it has completed its cycle, program 2 would start and run its cycle.

This method can be used to enable any, or all of the available programs on the controller.

NOTE: *When running programs in manual mode the “Budget %” will alter the running times of each individual station.*

MANUAL OPERATIONS

Manually Test All the Stations

To manually test all the stations in sequence, turn the dial to “Run System Test”.

The display will show:

Press ► to run all stations for the default run time of 2 mins per station.

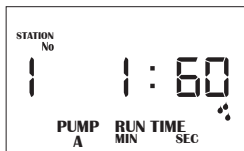

The controller will start running all stations with the default run time. The time will decrement in the display and will sequentially move through all stations, running them for the same set period of time. This option is designed so that it is possible to test all sprinklers and valves that make up the irrigation design.

To fast skip to the next station press the ► button. To stop the system test, change the position of the main dial, to “OFF”.

OTHER FEATURES

Stop Watering

To stop an automatic or manual watering schedule, turn the dial to the “OFF” position.

NOTE: For automatic watering remember to turn the dial back to the “Auto” position, as “OFF” will stop any future watering cycles from occurring.

Stacking Start Times

Should you accidentally set the same watering start time on more than one program, the controller will “stack” them in sequential order. All programmed start times will be watered from the highest number first.

Automatic Backup

This product is fitted with permanent memory. This allows the controller to hold all stowed values even in the absence of power sources, which means that programmed information will never be lost. Fitting the 9 volt block battery is recommended to extend the life of the coin battery and it will provide sufficient power to light up the display. However, if the battery is not fitted the real time clock is backed up with a Lithium coin battery that has been factory fitted. This means that when the power returns the clock will be restored to the current time.

It is recommended that the 9V battery is fitted and it is changed every 12 months.

A “Fault Bat”  icon will show in the display when the battery has a week left to run. When this occurs, replace the battery as soon as possible.

Note: If the AC power is off, the display will not be visible, unless a 9V battery has been installed.

OTHER FEATURES

Rain Sensor

When installing a rain sensor, first remove the the factory fitted link between the “SENS” and “COM” terminals shown here, by the plate.

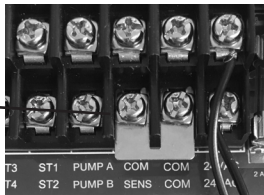



Replace with the two wires from the rain sensor into these terminals, polarity NOT required. Move the rain sensor switch on the fascia to “ON”.

Turn the dial to “Auxiliaries” to enable individual stations to be set rain sensor “ON” or “OFF”.

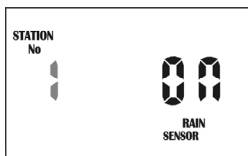
The display will show:



If the station is turned “ON” this means that the sensor will control it, should it rain. The default mode is for all stations to be rain sensor “ON”. Should you have a station (valve) that always needs to be watered, e.g. an enclosed green house or plants that are under cover, then the rain sensor can be turned “OFF” for these particular stations. This way when the sensor is wet they will still water. To select a station to turn “OFF”. Press the  button, the rain sensor is now switched off for this station.

TIP: To turn the station back “ON” press the  button. To advance to the next station use the  button and the station number will increment. Do this operation for all stations (valves) on the controller that need to be altered.

HINT: To disable the rain sensor and allow all stations to water regardless of the setting, move the slide switch marked Rain/Sensor to the “OFF” position. To reactivate it slide the switch to the “ON” position.

OTHER FEATURES

Rain Delay (Rain sensor cont...)

Different rain sensors react in different ways. The most common complaint about rain sensors, is that they dry out too quickly, and allow the system to come on within hours of a rain storm. To counter this problem the controller has a “Rain Delay” setting that allows a specific delay time to elapse after the rain switch has dried out before the controller will water again. Turn the dial to the “Auxiliaries” position. Then press the ◀ button. The rain delay value will now be flashing.

The display will show:

Press the + button to alter the rain delay time in increments of 24 hours at a time.

A maximum delay of 9 days can be set.



Stop All Watering

To stop all watering cycles during winter, turn the dial to the “OFF” position.

The display will show “ALL OFF”:

This means that all automatic schedules will not come on, but the programmed information is still retained in the memory and the clock still keeps track of time even though it is no longer being displayed.

To reactivate watering, turn the dial to the “Auto” position.



Dual Pump Selection

This unit will allow stations to be assigned to Pump A, Pump B or both Pumps (A+B).

This can be done by individual stations, or per program (one or the other).

The default position is that all stations are assigned to Pump A. To change individual stations, turn dial to “Pumps” position and

the display will show:

Press ▶ to advance the station number and ■ to change from “ON” to “OFF” if required.

Then press P again to add stations to “Pump B” if required.

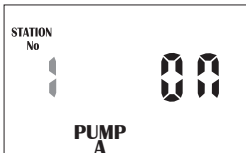

OTHER FEATURES

This is for individual station selection, and if you prefer to set this feature by program the controller will only allow one on or the other.

Select Dual Pumps by Program:

Turn the dial to “Pumps” position and press **P** twice,

the display will show:

To set all the stations in program number 1 to pump A, press **+** and the

display will show:

Now all the stations assigned to program 1, will be set to “Pump A”. If you require another program assigned to Pump A press **▶** to advance to the program number required, and then press **+** to set to “ON”. Each program can be assigned to Pump A, Pump B or both pumps (A+B). To advance to Pump B selection, press **P** until the

display shows:

To assign all the stations in program 1 to “Pump B”, press **+** and the display will show “Program No. 1. Pump B “ON”. Proceed to program 2 by pressing **▶** if required and assign to “ON” by pressing **+**. Proceed in this way, as required.

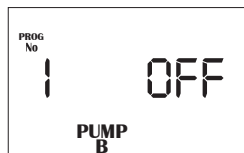
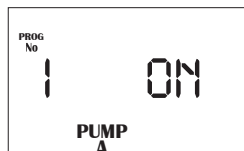
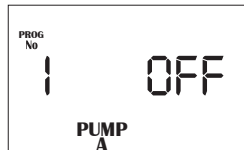

OTHER FEATURES

Water Budgeting & Seasonal Adjustment

The automatic station run times can be adjusted by percentage as the seasons change. This will save valuable water as the run times can be adjusted quickly in spring, summer, and autumn to reduce or increase water usage.

Note: This can be set for each month from “OFF” to 200% in 10% increments. It is important to set the calendar as shown on page 8 and the budget will change for each month.

Turn the dial to “Seasonal Adjust” position.

The display will show:

This means that the run times are set to 100%, i.e. if station 1 is set to 10 minutes then it will run for 10 minutes.

Should however the value change to say 50% then instead of running for 10 minutes station 1 would now run for 50% of 10 minutes, i.e. 5 minutes.

Conversely should the budget value be altered to show 200% then instead of running 10 minutes on station 1, it would run for 20 minutes. The budget calculation is applied to all stations and all run times that are active.

To increase the budget percentage press the **+**, to decrease the budget percentage press the **-**. The percentage value will increment or decrement in multiples of 10%. The maximum value is 200% and the minimum value is “OFF”.

Continue to press **▶** and either leave the month at 100% (this means the automatic run times will not change) or adjust with **+** or **-**. The permanent memory function will retain the information.

To return to the clock display turn the dial to “Auto Run”.

Should the budget value no longer be 100% then it will be shown in the clock display, e.g. if we set the budget to 200%

The display will show:

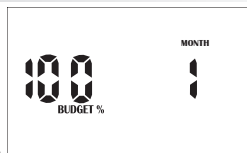



SPECIAL FUNCTIONS

Current Sensing and Faulty Station Skip

This unit has a M205 2AMP Glass Fuse to protect the transformer and pump/master valve, from power surges, and an electronic fuse to protect the circuit from field or valve faults. The electronic fuse has a cut-off point of 1.5AMPS and any field fault drawing a current higher than this will cause the unit to shut the station output off and then skip to the next available station. This fault will be displayed as “Fuse Fault” and STN__. The faulty station number will be shown in the display until 12:00pm and the unit will also beep every 5 seconds. If there are multiple station faults, only the last station number will be displayed, and the controller will clear the fault display at midnight and try again at the next run time. The controller is “Short Circuit Proofed” and will try to run the stations at the next available auto run time.

Note: To test or check the current for any station, move the dial to “Run Station”.

Advance with  to the station number that you require and press . The display will show the combined current AMPS that this station is using.

Note: This includes the combined pump/master current, as well as the selected station.

Fault Indication Feature

The following fault indications are shown in the display:

“NO AC” - Not connected to mains power or transformer not working.

“Fault Bat”  - 9V battery not connected or flat. Change battery.

“Fuse Fault Stn_” - Field wiring fault of faulty valve as shown in the STN__.

Check and fix field fault.

SPECIAL FUNCTIONS “PUMPS”

Pressure Build (bld)

The pressure build system is used to allow the recovery of water supplies and to speed up slow valve changes within a system.

Basically what happens is, as the controller changes from one valve to another, a system delay is inserted between valves. In essence, during this delay period, the pump is working against a closed head. The advantage of this is that in systems where the valves are slow to change, it is possible to speed them up by inserting a delay period and pressurizing the main line. This system can also be used on wells and bores, where draw down can occur or cavitation of central pumps is a problem.

WARNING: *This option is used to make pumps work against closed heads. This can lead to pump failure, pipe splitting and in some cases, explosion of pressure vessels. Understand how to use this option and consult a hydraulic engineer regarding the use of this option in your system before implementing it.*

To access the pressure build option, turn the dial to the “Pumps” position, press the **P** button until the following display appears.

The display will show:



Press **+** to change “OFF” to “ON”, then press **▶**

The display will show 0 00secs. Press **+** to set the delay between stations in seconds, from 0 00 in 1 second increments up to a maximum of 255sec. Basically this sets a delay between stations, while the pump is running.

SPECIAL FUNCTIONS “PUMPS”

Pressure Relief (rELF)

The pressure relief is used to stop fast valve closures causing water hammer and damaging pumps and pipe work.

This facility allows the overlap of valves for a specified time between valve changes. For example the system is changing from valve one to valve two.

1. Valve one is open
2. Valve two opens
3. Time delay counts down
4. When time elapses valve one closes
5. Valve two now runs for its specified run time.

To access the pressure relief feature, turn the dial to the “Pumps” position. Then press the **P** button till the following display appears.



Press the **+** to change “OFF” to “ON”, then press **▶**.

The display will show 00secs. Basically this sets the overlap time in seconds between stations. Press **+** to select in seconds.

Select from 1 second up to a maximum of 255 seconds.

SPECIAL FUNCTIONS “PUMPS”

Well Recharge (rECH)

The well recharge feature is used to turn the pump off for a selected time (in hours/minutes) to allow the well to refill the water level. To access the well recharge feature, turn the dial to the “Pumps” position, press the **P** button until the display shows the following.

Press **+** to activate this function and the “OFF” will change to “ON”. Press **▶** the display will show 0Hrs 00min, and the minutes will be flashing. Adjust with **+**.

If a longer time is required press **▶** and the hrs will start flashing. Adjust with **+**. The maximum time that can be set is 12 hours 59mins.



SPECIAL FUNCTIONS “AUXILIARIES”

Looping Program

The looping feature requires the last program in the unit to be used for this function. The looping program can be set in Hours/Minutes or in Minutes/Seconds. A delay time can be programmed between loops, and the number of loops can also be programmed. The looping program will run exclusively with other stations. When in the exclusive mode the looping program will take control of the system and run any other programs only when it goes into the “delay between loops mode”. Be careful when using this mode. Large looping cycles and small delay times can mean that there is not enough time per day to run a complete cycle. The controller will then stack the following day’s program starts.

Before setting your looping routine it is necessary to program a start time, set watering days and station run times in program 6. This program records the looping program.

Note: The run time at this point can only be set in Hours/Minutes, and this will automatically convert to Minutes/Seconds if this option is selected when setting up the looping routine in the “Auxiliaries” position.

To set the looping routine turn the dial to the “Auxiliaries” position. Press the **P** button two times until the display appears:

To enable the looping program press **+** and the display will show “LOOP ON”. To disable the looping program press **■** and the display will show “LOOP OFF”.



LOOP OFF

There are two looping functions; standard and continuous (frost control).

Standard looping: Standard looping is generally used for greenhouses and nursery applications, and is also suitable for new turf installations.

SPECIAL FUNCTIONS “AUXILIARIES”

Continuous looping: This system is used for frost control using a temperature probe. Connect the probe to the sensor terminals “SENS” and “COM” and slide the RAIN SENSOR switch to the “ON” position and remove the link (if fitted). The looping can now be activated via the sensor input, breaking the contact between the “SENS” and “COM” terminals will cause the looping program to stop till the contacts close again.

Looping Program

Once the looping program is enabled it is possible to gain access to its menu by pressing **▶**.

1) The No of loops will be flashing. The display will show:

adjust the loops by pressing **+** or **■**.

(You can choose to set up to 99 loops)

Setting the “**time between loops**”

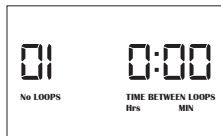

2) Once your chosen number of loops is displayed press **▶**. The “Hrs” and “Min” will be flashing. This is where you set your time between loops. If you want to set the time between loops in Hrs/min, press **▶** to proceed, if you want to set the time between loops in Min/Sec format press **+**

3) Press **▶** until the “MIN” or “SEC” is flashing. Press **+** to adjust the time. Press **▶** for the “Hrs” or “MIN” to flash and press **+** if required.

Setting the “**loop run time**”

4) To progress to setting the loop run time press **▶**.

The display will show:

The “Hrs” and “MIN” will be flashing. This means that your run time will run in the Hrs/mins that were scheduled in program 6.

If you want to change the scheduled Hrs/mins to run in

Mins/Secs press **+** and the display will show:

with the “MIN” and “SECS” flashing.



When your selected format is flashing press **▶** to save the looping program.

SPECIAL FUNCTIONS “AUXILIARIES”

Continuous Looping

For continuous looping press **P** twice until the display shows:

Press **+** to change to “LOOP ON” and then follow as per standard loop. After setting the “time between loops” and the “loop run time” proceed to the next position by pressing **▶**.

The display will show:

Press **+** to change to “ON”. This sensor will now control the looping function.



LOOP OFF



SENS OFF
LOOPS

SPECIAL FUNCTIONS

Clearing the Programs

As this unit has a permanent memory feature, the best way to clear the programs is as follows:

Turn the dial to “Off” Press ► twice until the display shows.

Then Press **P**.



The clock will be retained, and the other functions for setting starts times, watering days and station run times will be cleared and returned to the start up settings.

The other option is to select the function on the dial which needs clearing and use the buttons to scroll through and adjust with **+** and **■** as required.

Program Rescue Feature

To upload Program Recall Feature turn the dial to the “OFF” position and press ◀ and ▶ simultaneously. “LOAD UP” will appear on the screen.

Then press **P**.

To Re-install Program Recall Feature turn the dial to the “OFF” position and press ►. Load will appear on the screen, then press **P**.

This will return to the original stored program.

INSTALLATION INSTRUCTIONS

Mounting the Controller

Install the controller near a 240 VAC outlet. Preferably located in a house, garage, or exterior electrical cubicle. For ease of operation, eye level placement is recommended. Ideally, your controller location should not be exposed to rain or areas prone to flooding or heavy water.

This inbuilt controller comes with an internal transformer and is suitable for **outdoor or indoor** installation. The housing is designed for outdoor installation but the plug needs to be installed in a weatherproof socket or under cover.

Fasten the controller using the key hole slot positioned externally on the top centre and the additional holes positioned internally under the terminal cover.

Electrical Hook-up

WARNING:

1. All electrical work must be carried out in accordance with these instructions following all applicable local, state and federal codes pertaining to the country of installation.
Failure to do so will void the controller's warranty.
2. Disconnect mains power supply before any maintenance work to the controller or valves is undertaken.
3. **Do not attempt to wire any high voltage items yourself, i.e. pumps and pump contactors or hard wiring the controller power supply to the mains. This is the field of a licensed electrician. Serious injury or death could result from improper hook up. If in doubt consult your regulatory body as to what is required.**

Field Wiring Connections

PREPARATION

1. Prepare wire for hook-up by cutting the wires to the correct length and stripping approximately 0.25 inches (6.0mm) of insulation from the end to be connected to the controller.
2. Ensure terminal block screws are loosened sufficiently to permit easy access for wire ends. Insert stripped wire ends into the clamp aperture and tighten screws. Do not over tighten as this may damage the terminal block.

INSTALLATION INSTRUCTIONS

3. A maximum of 1.0 Amps may be supplied by any output. Check the inrush current of your solenoid coils before connecting more than two valves to any one station. This can be done by using the “System Test” feature.

Power Supply Connections

INBUILT TRANSFORMER

It is recommended that the transformer is not connected to a 240 vac supply which is also servicing or supplying motors (i.e. air conditioners, pool pumps, refrigerators). Lighting circuits are suitable as power sources.

This inbuilt transformer model, is suitable for outdoor installation as the housing is weatherproof and UV stabilized. However it is recommended that the unit be installed in an area which is not exposed directly to the weather.

Terminal Block Layout (18 station example)

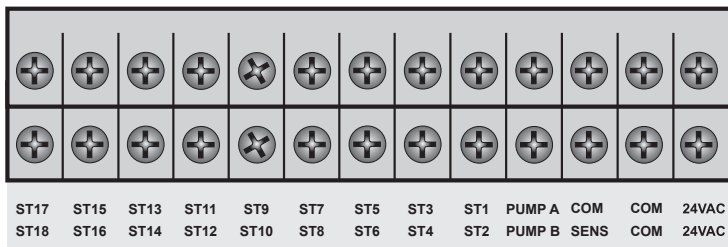

USE 2 AMP FUSE

GLOSSARY

24 VAC	24VAC power supply connection
COM	Common wire connection to field wiring
SENS	Input for rain switch
PUMP A	Master valve or pump start output
PUMP B	Master valve or pump start output
ST1–ST18	Station(s) (valves) field connections

INSTALLATION INSTRUCTIONS

Pump Start Relay Connection (Water supply by pump system)

This controller does not provide mains power to drive a pump. A pump must be driven via an external relay and contactor setup as detailed below. The controller provides a low voltage signal that actuates the relay which in turn enables the contactor and finally the pump.

HINT: Although the controller has permanent memory and thus a default program will not cause erroneous valve actuation as in some controllers, it is still good practice when using a system where the water supply comes from a pump to connect unused stations on the unit back to the last used station. This in effect, inhibits the chances of the pump ever running against a closed head.

Single Phase Pump Installation

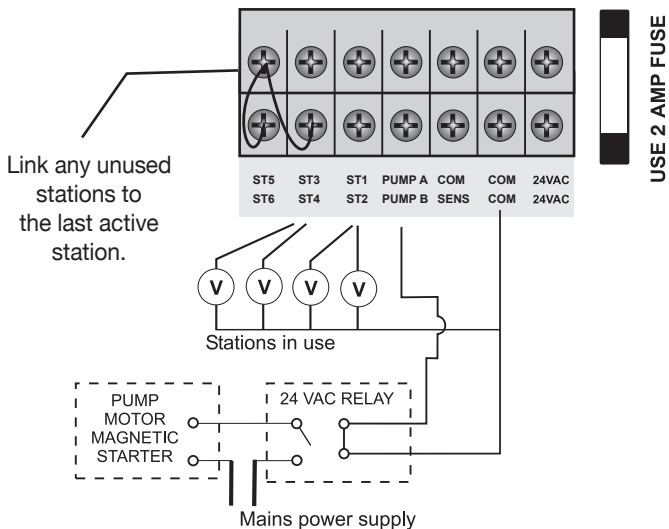

Note: It is recommended to always use a relay between the controller and the pump starter.

INSTALLATION INSTRUCTIONS

Master Valve Installation (Water supply off mains water)

The purpose of the master valve is to shut off the water supply to the irrigation system when there is a faulty valve or none of the stations are operating correctly. It's used like a back-up valve or fail safe device and is installed at the start of the irrigation system where it is connected to the water supply line.

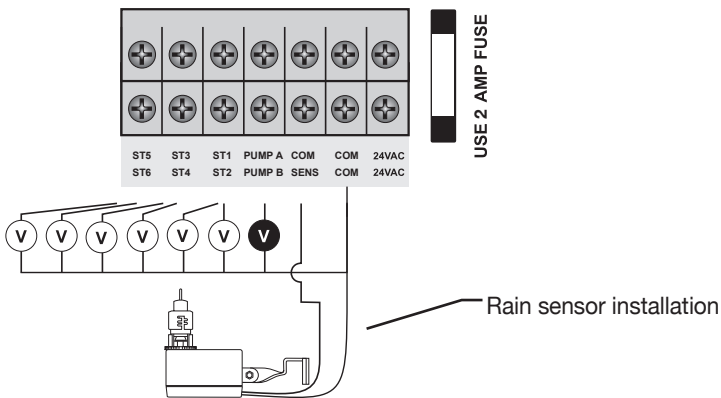

Power Supply Connections

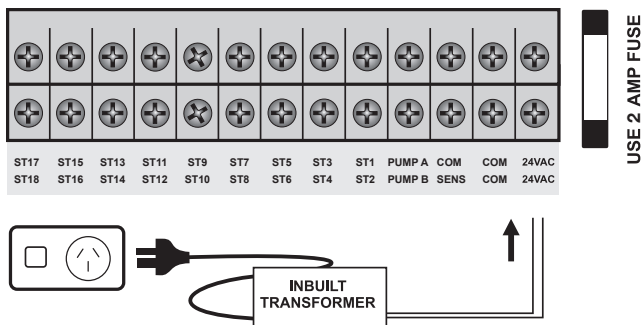

INSTALLATION INSTRUCTIONS

Station Valve Installation

Up to two 24 vac solenoid valves can be connected to each station output and wired back to the Common (COM) connector. When using long runs of cables, be aware that voltage drop can play a significant roll, especially when more than one coil is wired to a single station. As a good rule of thumb select your cable as follows:

0–50m	cable dia 0.5mm
50–100m	cable dia 1.0 mm
100–200m	cable dia 1.5mm
200–400m	cable dia 2.0mm

When you are using multiple valves per station the common wire needs to be much larger as it needs to carry more current. In these circumstances choose a common cable 1 or two sizes larger than required. When making connections in the field, only ever use gel filled or greased filled connectors. Most field failures occur due to poor connections. The better the connection here, and the better the waterproof seal the longer the system will perform without trouble.

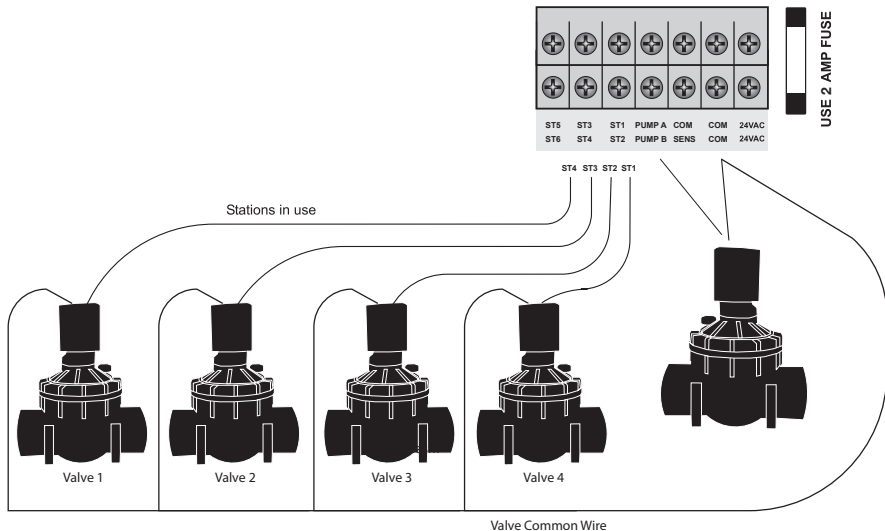

INSTALLATION INSTRUCTIONS

Pump Protection (System Test)

In some circumstances not all operational stations might be hooked up. For example, if the controller was capable of running 6 stations but there were only 4 field wires and solenoid valves available for connection. This situation can pose a risk to a pump when the system test routine for the controller is initiated.

The system test routine sequences through all available stations on the controller. In the above example this would mean stations 5 through to 6 would become active and would cause the pump to operate against a closed head. This could possibly cause permanent pump, pipe and pressure vessel damage.

It is mandatory if the system test routine is going to be used, that all unused, spare stations, should be linked together and then looped to the last working station with a valve on it.

Using the above example, the connector block should be wired as per the diagram below.

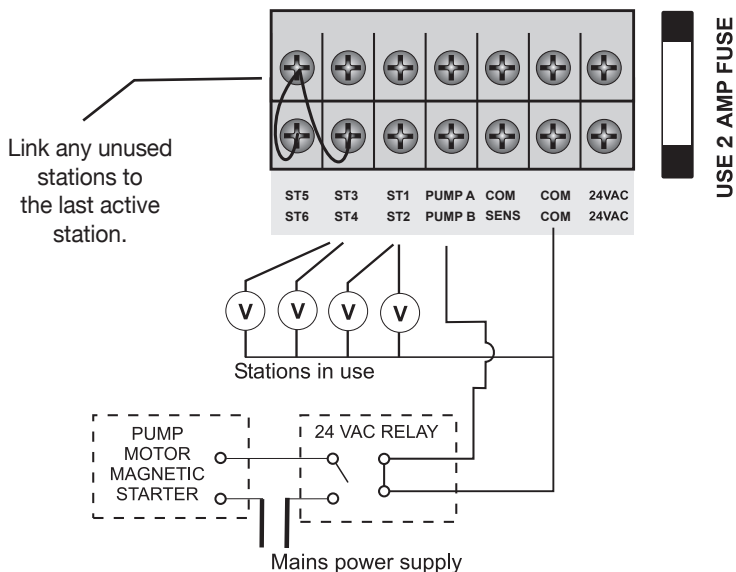

FAULT FINDING GUIDE

SYMPTOM	POSSIBLE CAUSE	SUGGESTION
No display	Faulty transformer, blown fuse.	Check fuse, check field wiring, check transformer.
Single station not working	Faulty solenoid coil, or break in field wire Check fault indicator in display	Check solenoid coil (a good solenoid coil should read around 33ohms on a multi meter). Test field cable for continuity. Test Common cable for continuity.
Fuse fault Stn shown in display	Incorrect wiring or bad connection. Solenoid coil has shorted through Test current with "System Test" function	Check solenoid coil (a good solenoid coil should read around 33ohms on a multi meter). Test field cable for continuity. Test Common cable for continuity. Test connections.
No automatic start	Programming error or blown fuse or transformer	If unit works manually then check the programming. If not then check the fuse, wiring and transformer.
Buttons not responding	Short on button or programming not correct Unit may be in sleep mode and no AC power	Check instruction book to ensure programming is correct. If buttons still not responding then return panel to supplier or manufacturer.
System coming on at random	Too many start times entered on automatic programs	Check number of start times entered on each program. All stations will run once for every start. If fault persists return panel to supplier.

FAULT FINDING GUIDE

SYMPTOM	POSSIBLE CAUSE	SUGGESTION
More than one station coming on at once	Possible faulty driver triac	Check wiring and swap faulty station wire's on the controller terminal block with known working stations. If the same outputs are still locked on, return panel to supplier or manufacturer.
Pump start chattering	Faulty relay or pump contactor	Electrician to check voltage on relay or contactor.
Display cracked or missing segments	Display damaged during transportation	Return panel to supplier or manufacturer.
Sensor input not working	Sensor enable switch in the OFF position or faulty wiring	Slide switch on front panel to the ON position, test all wiring and make sure the sensor is a normally closed type. Check programming to make sure sensor is enabled.
Pump not working on a specific station or program	Programming error with pump enable routine	Check programming, using the manual as a reference and correct mistakes.

ELECTRICAL CHARACTERISTICS

Electrical Outputs

POWER SUPPLY

Mains supply: This unit runs off a 240 volt 50 hertz single phase outlet.

The controller draws 30 watt at 240 VAC.

The internal transformer reduces the 240 VAC to an extra low voltage supply of 24 VAC. The internal transformer is fully compliant with AS/NZS 61558-2-6 and has been independently tested and judged to comply.

This unit has a 1.25AMP low energy, high efficient toroidal transformer for long life performance.

ELECTRICAL POWER SUPPLY: Input 24 volts 50/60Hz

ELECTRICAL OUTPUTS: Maximum of 1.5 amp

To solenoid valves:

24 vac 50/60Hz 1.0 amps max

***Note:** up to 3 valves per station on the inbuilt model*

To the master valve/pump start:

24 vac 0.25 amps max

***Note:** Transformer and fuse capacity must be compatible with output requirements*

OVERLOAD PROTECTION:

Standard 20mm M-205 2 amp fast blow glass fuse, protects against power surges and electronic fuse rated to 1.5 amp protects against field faults. Faulty station skip function.

POWER FAILURE:

The controller has permanent memory and real time clock, so the data is always backed up even with the absence of all power. The unit is factory fitted with a 3V CR2032 Lithium Battery with up to 10 years memory backup, to maintain the clock.

The 9V Alkaine battery is used for remote programming and is recommended to help maintain the life of the lithium battery.

***Note:** Tampering with the unit will void the warranty.*

ELECTRICAL CHARACTERISTICS

Note: The batteries do not run the outputs. The internal transformer requires mains power to run the valves.

WIRING:

The output circuits should be installed and protected in accordance with wiring code for your location.

Servicing the Controller

The controller should always be serviced by an authorised agent.

Follow these simple steps to return the unit:

1. Turn the mains power OFF to the controller.
 - a) If the controller is hardwired, a qualified electrician will be required to remove the entire unit depending on the fault.
 - b) Proceed to either unplug and return the entire controller with transformer or disconnect the panel assembly only for servicing or repair.
2. Disconnect the 24 VAC leads at the controller 24 VAC terminals on the very left hand side of the terminal block.
3. Clearly mark or identify all valve wires according to the terminals they are connected to. This allows you to easily wire them back to the controller, maintaining your valve watering scheme.
4. Disconnect valve wires from the terminal block.
5.
 - a) Remove the complete panel from the controller housing by unscrewing the two screws in the lower corners of the fascia. (both ends of the terminal block)
 - b) Remove the complete controller from the wall unplugging the lead.
6. Carefully wrap the panel or controller in protective wrapping and pack in a suitable box and return to your service agent or the manufacturer.

Note: *Tampering with the unit will void the warranty.*

7. Replace your controller panel by reversing this procedure.
The controller should always be serviced by an authorised agent.

SPARE WATERING PLANNER

VALVE NUMBER	6	7	13	14	15
1					
2					
3					
4					
5					

PROGRAM	START TIME	WATERING INTERVAL	NO. VALVES	RUN TIME (minutes)
4	1st Start Time:		1	10
	2nd Start Time:		2	11
	3rd Start Time:		3	12
	4th Start Time:		4	13
	5th Start Time:		5	14
	6th Start Time:		6	15
	7th Start Time:		7	16
	8th Start Time:		8	17
	9th Start Time:		9	18
	10th Start Time:		10	19

PROGRAM	START TIME	WATERING INTERVAL	NO. VALVES	RUN TIME (minutes)
5	1st Start Time:		1	10
	2nd Start Time:		2	11
	3rd Start Time:		3	12
	4th Start Time:		4	13
	5th Start Time:		5	14
	6th Start Time:		6	15
	7th Start Time:		7	16
	8th Start Time:		8	17
	9th Start Time:		9	18
	10th Start Time:		10	19

PROGRAM	START TIME	WATERING INTERVAL	NO. VALVES	RUN TIME (minutes)
6	1st Start Time:		1	10
	2nd Start Time:		2	11
	3rd Start Time:		3	12
	4th Start Time:		4	13
	5th Start Time:		5	14
	6th Start Time:		6	15
	7th Start Time:		7	16
	8th Start Time:		8	17
	9th Start Time:		9	18
	10th Start Time:		10	19

VALVE NUMBER	6	7	13	14	15
1					
2					
3					
4					
5					

PROGRAM	START TIME	WATERING INTERVAL	NO. VALVES	RUN TIME (minutes)
1	1st Start Time:		1	10
	2nd Start Time:		2	11
	3rd Start Time:		3	12
	4th Start Time:		4	13
	5th Start Time:		5	14
	6th Start Time:		6	15
	7th Start Time:		7	16
	8th Start Time:		8	17
	9th Start Time:		9	18
	10th Start Time:		10	19

PROGRAM	START TIME	WATERING INTERVAL	NO. VALVES	RUN TIME (minutes)
2	1st Start Time:		1	10
	2nd Start Time:		2	11
	3rd Start Time:		3	12
	4th Start Time:		4	13
	5th Start Time:		5	14
	6th Start Time:		6	15
	7th Start Time:		7	16
	8th Start Time:		8	17
	9th Start Time:		9	18
	10th Start Time:		10	19

PROGRAM	START TIME	WATERING INTERVAL	NO. VALVES	RUN TIME (minutes)
3	1st Start Time:		1	10
	2nd Start Time:		2	11
	3rd Start Time:		3	12
	4th Start Time:		4	13
	5th Start Time:		5	14
	6th Start Time:		6	15
	7th Start Time:		7	16
	8th Start Time:		8	17
	9th Start Time:		9	18
	10th Start Time:		10	19

GUARANTEE

The manufacturer Guarantees to the original purchaser that any product supplied by the manufacturer will be free from defects in materials and workmanship for a period of three years from the date of purchase. Any product found to have defects in material or workmanship within the period of this Guarantee shall be repaired or replaced by the manufacturer **FREE OF CHARGE**.

The guarantor does not guarantee the fitness for a particular purpose of its products and does not make any guarantee, expressed or implied, other than the guarantee contained herein. The guarantor shall not be liable for any loss from use of the product or incidental or consequential damages including damages to other parts of any installation of which this product is part.

The guarantee shall not apply to any equipment which is found to have been improperly installed, set up or used in any way not in accordance with the instructions supplied with this equipment, or to have been modified, repaired or altered in any way without the express written consent of the company. This guarantee shall not apply to any batteries or accessories used in the equipment covered under this guarantee or to any damage which may be caused by such batteries.

If the Controller develops a fault, the product or panel must be returned in adequate packing with:

1. A copy of your original invoice.
2. A description of any fault.

It is the purchasers responsibility to return the controller to the manufacturer or their agent by prepaid freight.

K
RAIN® **EX618**

HOLMAN INDUSTRIES

11 WALTERS DRIVE

OSBORNE PARK WA

6017

WWW.HOLMANINDUSTRIES.COM.AU